

Ham Rag

Rockford Amateur Radio Association

NOVEMBER, 1982

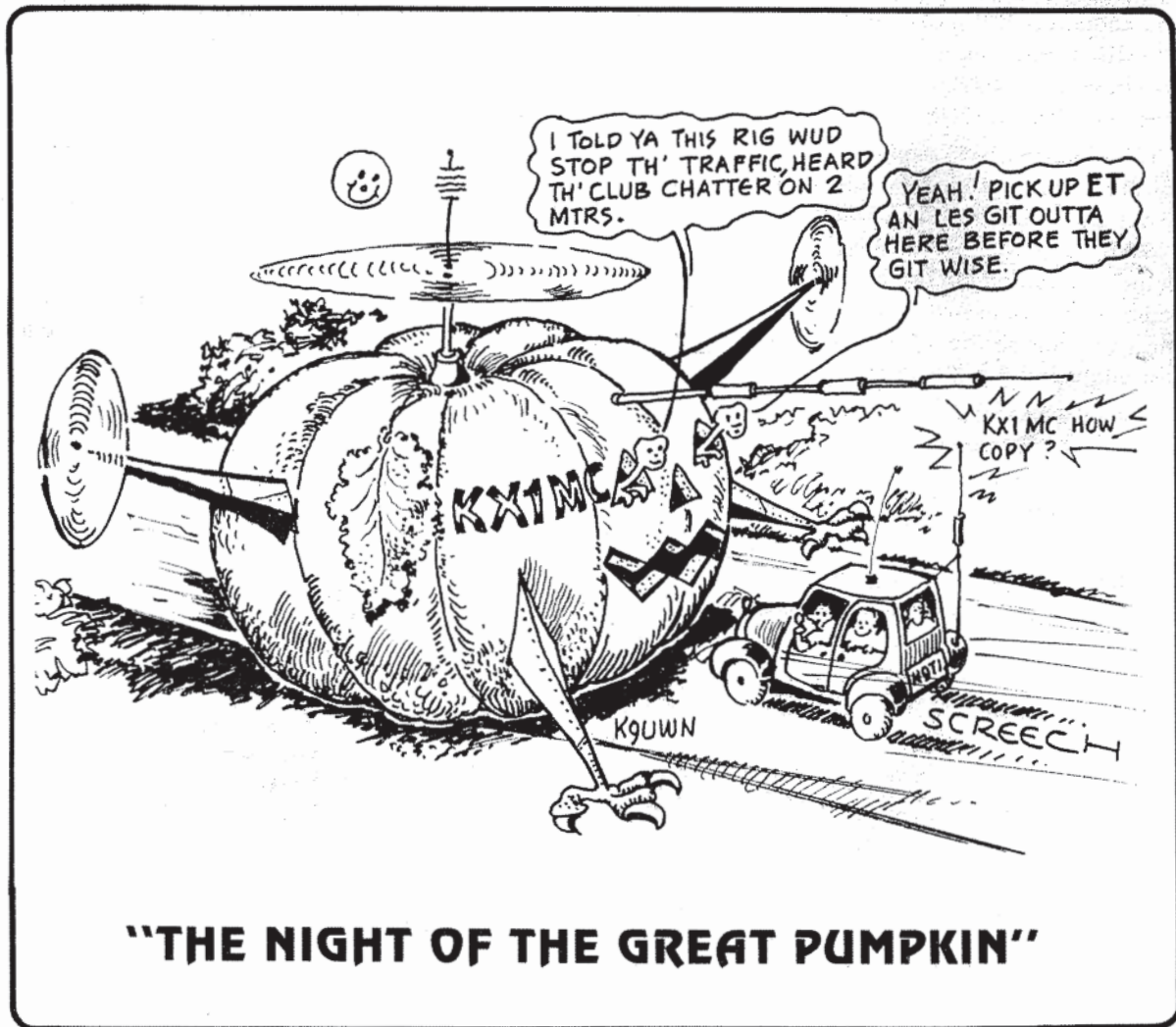

"THE NIGHT OF THE GREAT PUMPKIN"

President's Log

Gobble-Gobble — Just a few days 'till we tie into the big over stuffed bird. Probably (hopefully) it's the one time I can call all you hams -- turkeys. HI. Anyway, I hope everyone will have a "full" day.

Last month RARA had its annual election of officers. I would like to sincerely thank all of those who consented to run for the various offices. And also would like to congratulate those who were victorious. I hope you will continue to support the new leaders as you have the present regime. With you cooperation it makes the job easy and most of all **FUN**. Good luck to President Bob/WA9NTT, Vice President Chuck/N9CCH, Secretary Kay/KA90IY, and Treasurer Brad/KA9LTR.

I would also like to express the club's appreciation for the program put on by the computer enthusiasts of our group. Bill/KB9UR corralled Dick/N9UN, Dale-KB9WD, and Murry/N9MP to put together a fine demonstration on the use of computers and amateur radio. Also, not to overlook the game possibilities of the computer so the whole family can join in. This just might sell the XYL or OM.

Before we forget, we understand, as we write this log that, Al Horton/W9UFH is in SwedishAmerican Hospital. Hopefully it's nothing serious and he gets out real soon.

Also Steve/KB9IW and his family were in an auto accident with his wife requiring a stitch or two as well as his son. Fortunately no one was seriously injured-the car, however will probably need major surgery at Maaco.

The novice and general classes are going rather well. We have had several dropouts in the novice group but the generals are hanging in there.

With the good weather hanging in there, now is the last good chance to check the antenna system or get up that last dipole. However if you're really a good ham, give it another 4 to 6 weeks when it gets

good and cold and we have some snow before you attack the antennas. Moe/N9CCE just loves to send out those get well cards.

We have had an offer from Rock Valley College, Technology Division, to provide RARA with several keys in order that we may enter Building Number 1 and the radio station at our convenience. This matter of keys and where to place them will be taken up at our Board meeting. The college has also proposed that we again hold liscense classes at the college. This will be a possibility, but I believe it will require a few more volunteer teachers. The earliest these classes could begin at RVC would be fall of 1983.

The program for the November meeting will be presented by Illinois Bell Telephone. The subject will be the progress of the telephone system into the computer age. **See you November 12th, Building 1, Room 222.**

**El Lame-O Duck-O
Frank/KB9KH**



CQ Contest

The most difficult part of this column every month is to attract the reader's attention, so that his/her eyes remain glued to the page before he/she realizes what is happening. By then it is too late to do anything but finish reading these words and your lowly scribe has won again. What I was in reality trying to do was not to mention a word about the unraked leaves in my backyard or the windows that needed washing and caulking.

The latest issue of QST contains the results of last June's Field Day in which RARA did rather well. In category 6A (emergency power) we finished 15th out of 36 entries for a job well done for all involved. This result gives us something to shoot for next year.

The ARRL International DX Contest took place last February and March. RARA donates a plaque to the W/VE ham who submits the best score on QRP phone. This year's winner was KA1VQ from New Hampshire who had over 700 QSO's for almost half a million points. All this was done with an input power of ten watts or less. I wonder what kind of antenna he has.

WD9DBC also did well in the same contest. Jack finished with 385 QSO's and 142K points on phone and 380 QSO's for 160K points on CW. Both of these scores are for all bands. His CW finish was good enough for 4th place in Illinois. Nice going Jack. Also in the same 'test, the group here at AK9N (a multi-single with AA9Q, K9LJN, and N9AUZ in attendance) did not quite set the bands ablaze by any means! (especially compared to some of the scores in other call areas); but the certificate hanging here says we won 9-land CW. To keep things in their proper perspective though, the same score in 5-land would have put us DEAD LAST.

Russ/N9AWZ, finished well in the Can-Am contest last September, I believe he said first in 9-land CW, but my notes have not turned up so any specific numbers are gone. Still a good job, Russ.

There are a fair number of contests coming up in the next couple of months, so if you are not in the doghouse yet with the YL you can still make it. By now the CQ WW DX phone and ARRL SS CW contests are just memories. The weekend of November 20 and 21 is the SSB version of the ARRL Sweepstakes. Nothing at all complicated if you first do a bit of

reading on the rules. See the previous issue of the HAM RAG for a discussion on the exchange and October issue of QST page 92 for the complete rules. If you worked the CW portion of SSB and/or plan on working the SSB half and submit your score for the club competition, please let me (AK9N) know. Your name and call have to be sent in to ARRL for the score to be properly credited to RARA.

In case boredom sets in on Thanksgiving weekend, there is the CQ WW DX CW contest to take your mind off the lack of football games on the tube. The CQ World Wide contests are a fine way to find some new ones to expand the DXCC total or fill in some of the empty spots if 5BDXCC is your next goal. If you like to be on the air before, during, and after sunrise and sunset, there is a chance to pick up some DX on 40 and 80 meters. Your lowly scribe worked five or six JA's around six one Sunday morning on 80 with a meager dipole at 50 feet. Being in the correct place at the right time was a start, but the borrowed amplifier helped.

On page 84 in the November issue of QST are the rules for two contests that will take place in December. The ARRL 160 meter contest is set for the weekend of the 3rd, 4th and 5th. So if the rig has 1.8MHZ capability, load up that tower, rain gutter, chain link fence, or a long hunk of wire. Send RST and ARRL section, and receive RST and ARRL section or country. Obviously from the exchange this is a CW only contest.

The ARRL then meter takes place the second weekend (11-12 GMT) of December. This contest is normally a pretty lively affair and in less than ten days open all night, a good night's sleep should be possible. With the sunspots declining though, it should be easy to get some rest. Of course the band will be open to Japan while I'm asleep. Exchange RS(T) and state or a serial number from DX stations. Paul, W9OPD, placed first in Illinois in this one last year. Log sheets for the 160 and 10 meter contests along with sheets for SS will be available at the next RARA meeting.

Here's hoping we'll see each other there for an eyeball.

Gene

November, 1979

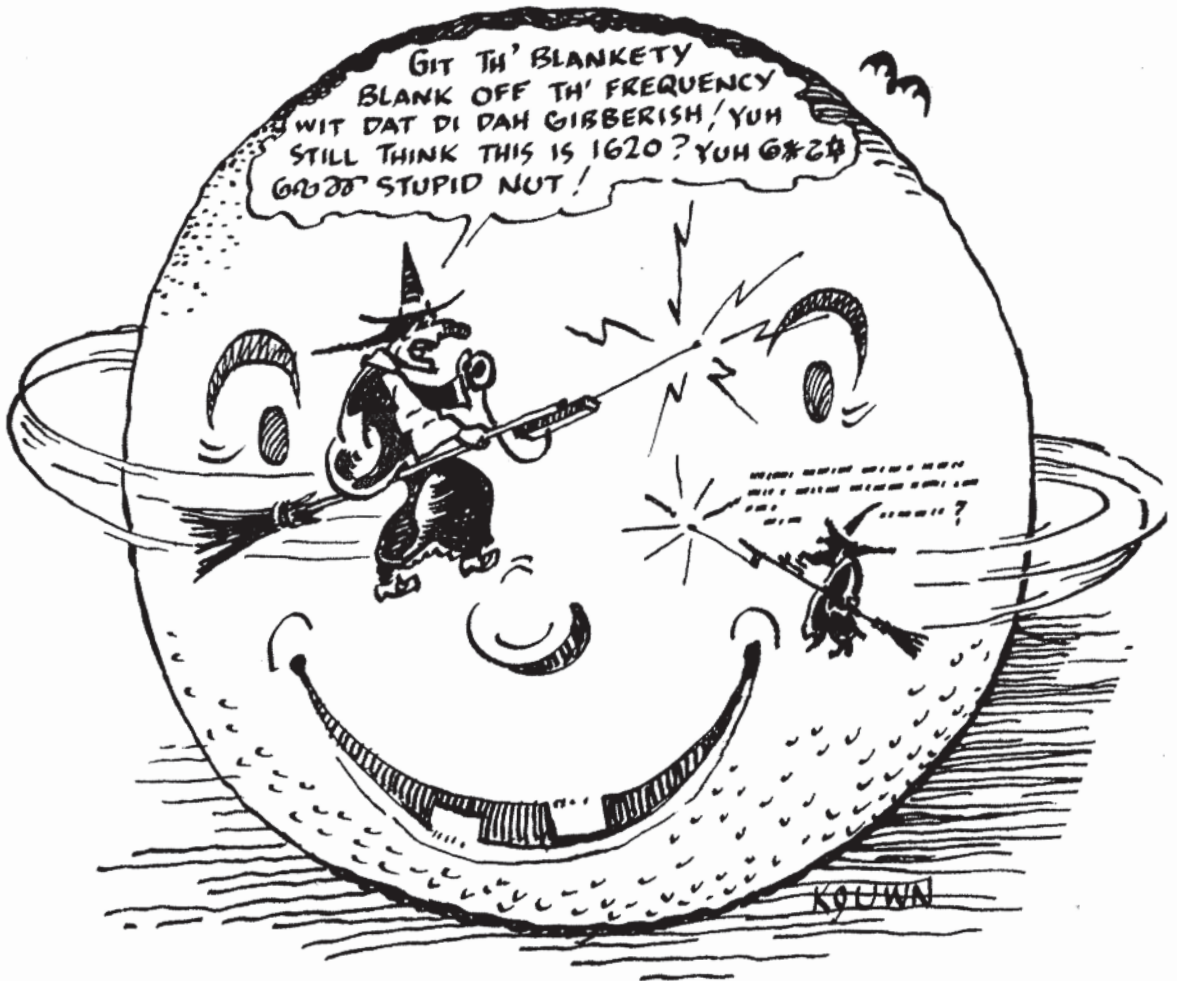

Editor's QRM

You picked up your copy of **HAM RAG** and knew immediately that something was different. It seemed too heavy-too thick. Well you were right. This month's issue contains the four missing pages from last month. Due to the lack of articles we were forced to cut back in October, but last month's lasck is this month's abundance.

To begin with the **HAM RAG** has acquired the mug shots of next year officers. Now, while everyone else is congratulating the winners I wish to point a finger at the losers. These people were willing to give of their time and talent for the benefit of the club. They are found guilty of caring in the first degree. I thank them all for trying and wish we could print their picture too.

The printing of photos is also a way we can learn to ID those newer members. Both the general and novice classes were captured on film and photos of the instructors are also included. **WELCOME** new hams.

Other points of interest this month includes a technical bench idea from the labs over at KB9IW's, pictures of the biggest hamfest in Europe, *HAM OF THE YEAR* ballots, and some classic covers from old *HAM RAG*'s.

-73, K19F
Jim

ROCKFORD AMATEUR RADIO ASSOCIATION, INC.
P.O. BOX 1744, ROCKFORD, ILLINOIS 61110

OFFICERS			1982	DIRECTORS		
President	Frank Hirsch	KB9KH	397-6966	Bruce Hamilton	KB9OW	963-6606
V. Pres.	James Ambruoso	WD9FVF	654-3620	Frank Baker	WB9OGD	623-2008
Sec'y	Maurice Bolte	N9CCE	877-5439	Zygmunt Podgorny	W9MOS	968-1244
Treasurer	Dale Mather	KC9BN	399-2002	Gene Melton	AK9N	654-0675
HAM RAG Editor				Associate Editors		
	Jim Milhone	K19F	633-9235	Jim Ambruoso	WD9FVF	654-3620
Distribution Manager * Photos & Layouts				Gene Melton	AK9N	654-0675
	Carol Holmes	K19G	633-3249	Dick Steinhauser	N9UN	397-6653
Circulation Manager				Gertrude Kindell	KB9PC	963-4050
	Dale Landis	KB9WD	633-0520	Gene Harlan	WB9MMM	398-2683
Artists				Gene Duncan	K9IKP	393-4751
	Jack Stuman	K9UWN	399-3890	Dennis Eksten	W9SS	877-6768
	Bob Davidson	WA9NTT	877-6274	Chuck Henley	N9CCH	633-6524
	Gertrude Kindell	KB9PC	963-4050			

INSTRUCTORS & NOVICE CLASS

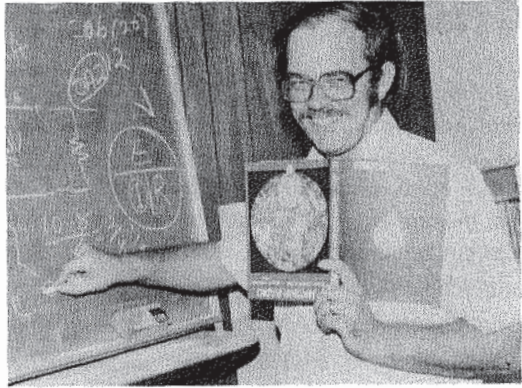
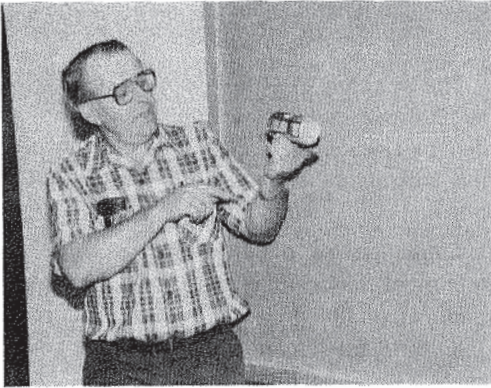

**FRANK KB9KH
THEORY NOVICE**
**GENE AK9N
THEORY GENERAL**
**CAROL K19G
CW NOVICE
RULES & REGS. GENERAL**
**DALE KC9BN
RULES & REGS. NOVICE**

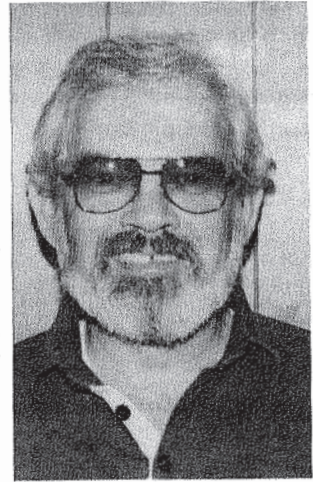

DICK RESSOR

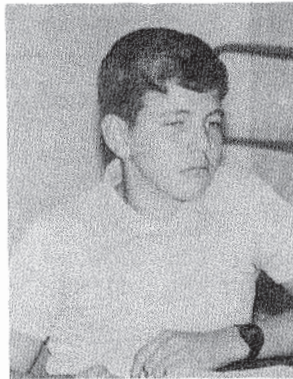

TIM NEESE



BRIAN AHLGREN

PHOTO MISSING OF JOHN NEESE

November, 1978



JACK
K9UWN

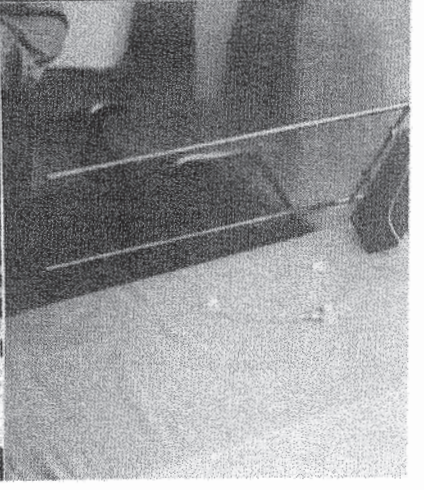
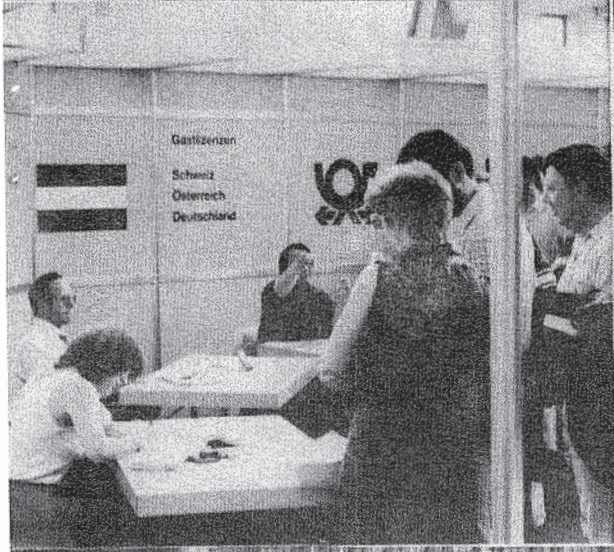

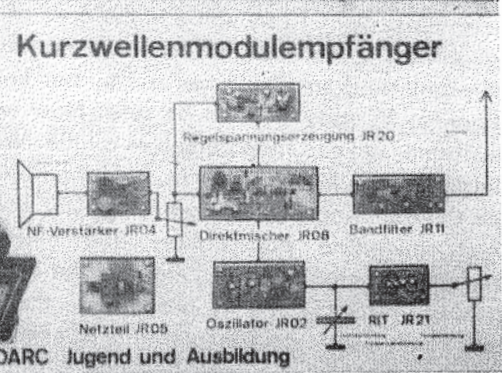
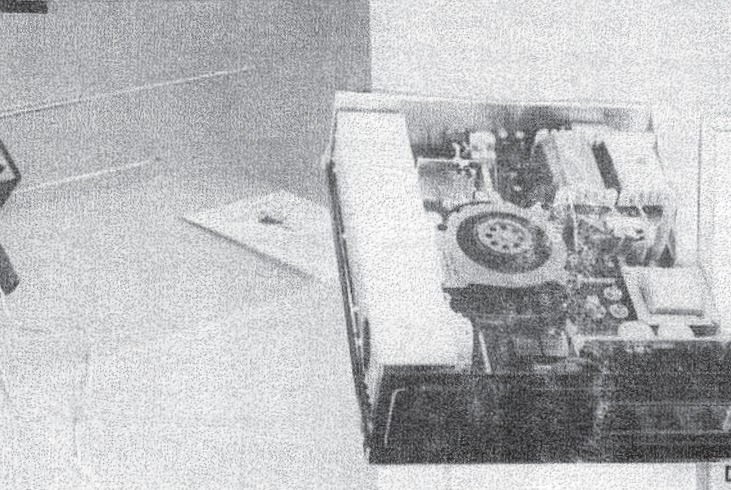
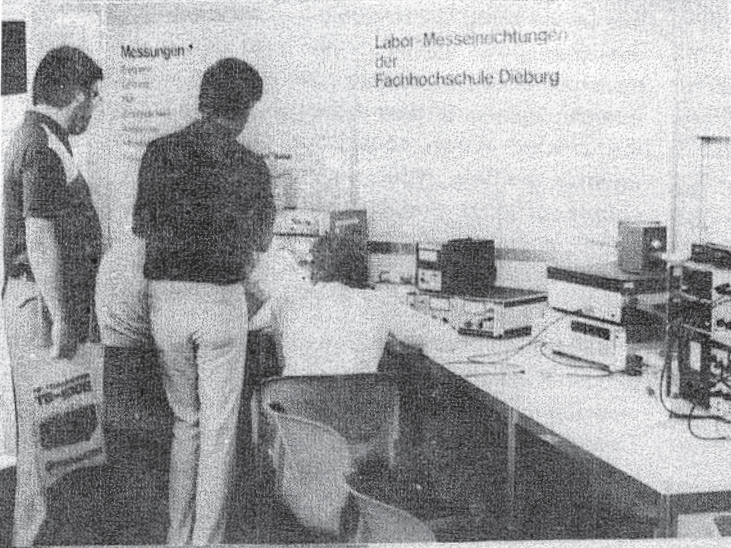
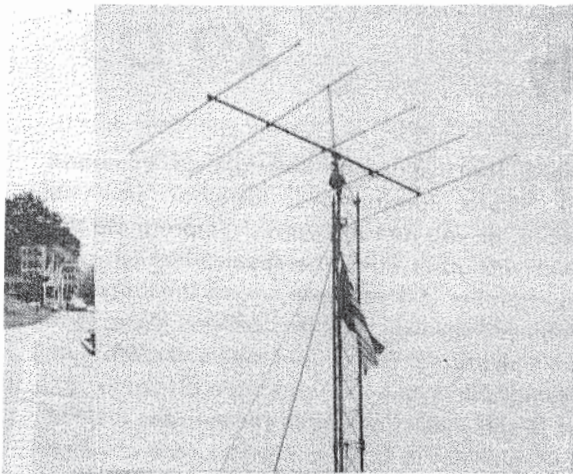

Shoestring Power Supply

So you went to the last hamfest and blew three bills on one of those 25W 2 meter rigs, huh? It's all synthesized with enough memory to be smarter than you are. Now you've got it home and the book says it needs 5 amps out of your old 3 amp power supply (so *what's the book know*). And now it's plugged in and the supply is smoking and warming the shack and Shari says that besides the hum on your signal you're not making it as well as the guy in Roscoe with the H/T (*probably Dean running a 1/4 KW H/T*). So now you don't know where the 50 to 80 bucks is coming from for the right supply. Well find the junk box cause we can slap one of these together for under 20 bucks with a little luck, and it's got so few components we can count them on your fingers.

Take a look at the schematics and you'll see modern science has got this voltage regulation stuff down to three terminal widgets, and they are smart enough to know if you are trying to fry them. The LM338 will give you 7 amps peak current and 5 amps continuously all the while making sure that it doesn't overheat. Two resistors, or one and a potentiometer will set the voltage and keep it within a few millivolts of where you want it.

Now let's look at how to keep this cheap. The transformer (T1), the LM338, and the capacitor (C1) are the big items. The last two we can't do without, so knuckle under and buy the LM338 at another hamfest or from a supply house (around \$7), and scrounge some big capacitors from the junkbox or that hamfest. For C1 any value in the area of 10,000 mfd. will do, or about \$7 worth even at Radio Shack, and paralleling smaller ones is OK, but keep the voltage at 35 volts or 50 to be safe. Now with the transformer we can help ourselves a little. We need around 18 volts RMS at 5 amps. and the new prices aren't cheap. Dig out October 1980 QST and read about rewinding transformers and modify the transformer from the dead TV across the basement. You'll run into a couple of problems -- the voltage won't come out right (*wind a couple of extra taps on the primary to adjust*), and the thing will hum like

the dickens. That last one is the roughest -- you need to stick those laminations together as you reassemble, or you need to varnish impregnate the thing and you don't have the special varnish or a vacuum chamber. Never fear -- use the left over polyurethane varnish in the cellar. Wrap the rewound transformer in a couple layers of aluminum foil leaving the top open and heat it up to 200 degrees in the oven (*late night please, she'll sleep right through this*) to bake out moisture and warm the whole thing (*30 minutes will do it*). Then yank it out and pour the varnish over it so that the transformer is completely covered. The warmth will thin the varnish and as it cools it will be sucked into the cracks. When cool pour off the excess and unwrap the foil. After wiping it clean, let it dry a couple of days and bake it again if you wish (*I didn't, she wouldn't miss that*) or let it cure on its own accord as it runs, once the supply is built. There you have it, a rewound transformer without hum.

Bolt all the parts together with the LM338 on a heat sink (*or aluminum plate about 4" X 6"*) and remember it's care is the output, so insulate the LM338 or the heatsink from ground. A couple of other comments -- C2 is there as a precaution to keep any oscillations from occurring at the voltage regulator, R4 keeps a minimum load on the system (*the LM338 needs at least 10 ma. load*). R1, R2, and R3 are set up to provide voltage adjustment around the 12 VDC area, not down to zero, to improve adjustment resolution. Finally, although I didn't find it necessary, a capacitor on the output will improve transient response, and may be appropriate for SSB rigs -- use a one microfarad solid tantalum. There is nothing critical about the parts arrangement, so use your imagination and enjoy putting this one together.

CQ DX

DXing from the view of a "Little Pistol".

I don't know how many of you are involved in chasing DX without the benefit of a linear or a large antenna system but this month this column is for you.

Two who have their DXCC that way are Milt Carlson/W9FFQ and Gary Hilker/K9LJN. Milt makes all his contacts on CW and has 120, while Gary works both SSB and CW and has 169. Both use wire antennas and in Milt's case, also a vertical. Gary, since he moved to the Rockford area from Milton, WI, has worked 87 SSB and 98 CW with 138 mixed into DXCC.

I'm not going into great detail on operating practices but will try to set down some of the basics I've found helpful and I'm sure others will agree with me.

First off, it takes a lot of listening, luck and practice. Listen to make sure of the call, whether he's operating split or transceiver, how he's picking calls and his general operating habits. Luck comes from coming across the DX station and patience at not giving up after a couple of calls. I always give my call twice slowly using standard phonetics or geographic names, then wait until the DX station puts out another call. It's surprising how often the DX operator hears part of the call and comes back.

I can't emphasize the importance of using phonetics which are familiar to the DX as well as locally. I heard a guy who had "RF" as his suffix trying to make a French operator understand. RF was using Radio Frequency as his phonetics and wasn't about to change it and the Frenchman couldn't understand him. Several minutes were spent getting it cleared up, much to the disgust of others waiting on the list.

Speaking of lists, I'm a firm believer in both nets and lists. About half of my contacts have been made on my own and the rest by checking into nets and list operations. Here are some of the ones I've found most helpful for myself as a general class ticket holder. **International Amateur Radio Society** with nets at 14.297 kHz starting at 0200 to 0600 and

21.370 kHz starting at 0000 to 0300. These nets are daily and come on one hour earlier to pass out QSL information. Also a 40 meter net on Saturday and Sunday at 7.238 at 0745. All times are in UTC. Information on this net can be obtained by sending a legal size SASE to: **International Amateur Radio Society, P.O. Box IARS, Glendale, CA 91206-7609.**

YL International SSB'ers, Inc. This system operates at 14.332 kHz daily. It starts with a DX portion at 1130 to 1330, followed by a warmup session from 1330 to 1600 when the formal sessions begin. At 2330, the Moonbeams portion begins and lasts until the band goes out. Also, on Tuesday and Thursday, there is an Open House session which begins at 0930 with Australian stations as control.

The YL system also operates on 75, 40, 15 and 10 meters. Information on the system may be obtained by a legal size SASE to: **Johnny Madden, WA1KVC, — 347 Western Ave. Lynn, Mass. 01904.** Other nets are: Africana net, 21.355 at 1700 daily; the DK2OC net at 28.750 at 1100 and the W7PHO Family Hours on 20, 15 and 10 meters.

Here are some of the stations work or heard this last month.

H44BS	Solomon Is.	K9LJN	20 SSB
ZM7AG	Tokelau Is.	K9LJN	20 SSB
1A0KM	Knights of Malta	K9LJN	10 CW
C31NP	Andorra	K9LJN	10 CW
F6FIC/TZ	Mali	K9LJN	10 SSB
ZL4OY/A	Auckland Is.	K9LJN	10 SSB
CE0ERZ		K9LJN	40 SSB
SM0AGD/KH1	Canton Is. (Central Kiribati)	K9LJN	
VP8AOE	S. Okney Is.	WB9LEF	20 SSB
CE0AEaster Is.	WB9LEF	20 SSB	
KH6IMX/KH4	Midway Is.	WB9LEF	20 SSB
PY0ZZ	Fernando de Noronha	WB9LEF	15 SSB

If any of the rest of you have more information, pass it on to Gene/K9IKP. Hope to see more of you in the DXCC.

**-73, Good DX
Duane, WB9LEF**

RARA OFFICERS ELECTED FOR 1983

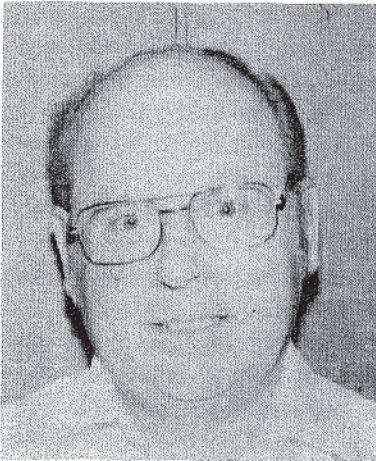

BOB WA9NTT
President

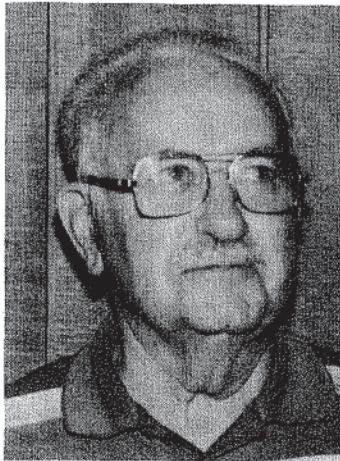

CHUCK N9CCH
Vice President

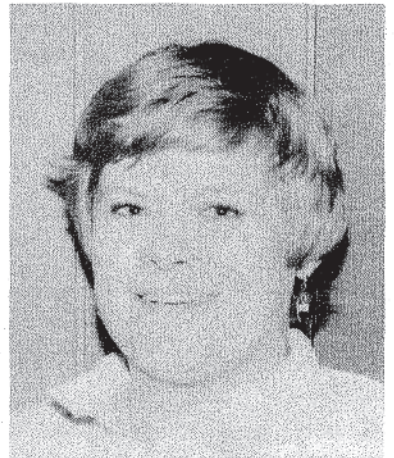

KAY KA9O1Y
Secretary

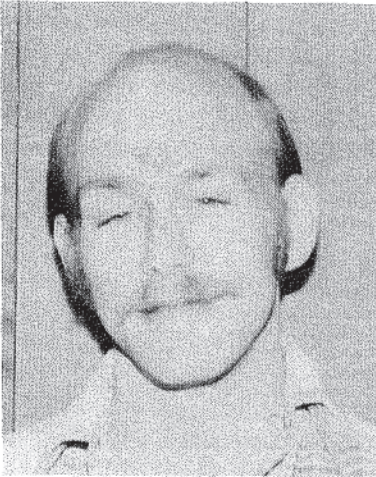

BRAD KA9LTR
Treasurer

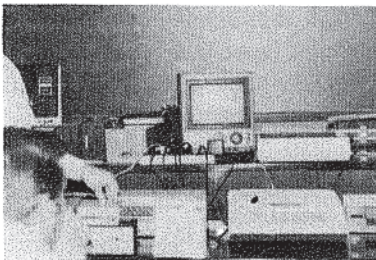
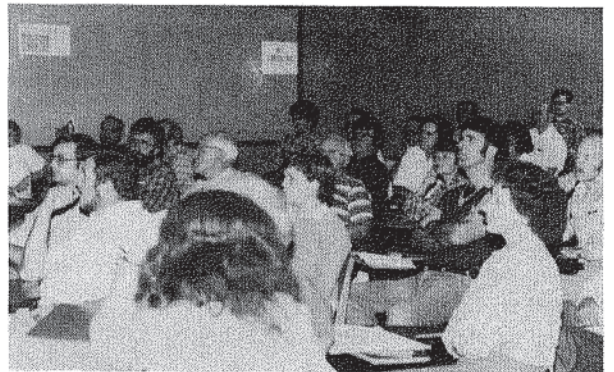

Shoestring Power Supply Con't

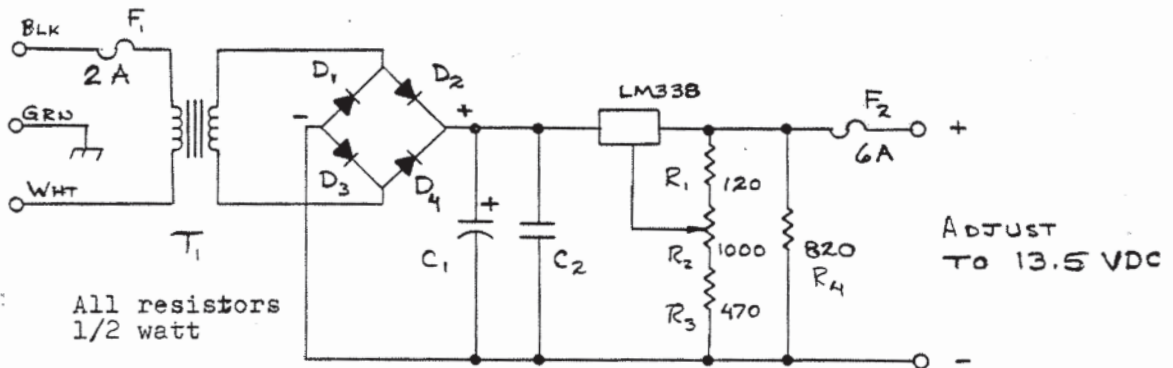

Suggested parts -- most, like the LM338 are available from outfits like Jameco, or locally at Midwest or J&M. Radio Shack part numbers are shown for selected components.

- C1 - two 4700 mfd/35v (272-1022) see text.
- C2 - .1 mfd/50v ceramic.
- D1-D4 - 6A/50PIV bridge (276-1180)
- R2 - 1000 ohm pot (271-227)
- T1 - See text
- Fuseholder (270-739)

KB9IW, STEVE

HAM OF THE YEAR NOMINATION BALLOT

Nominee _____ Call _____

I feel that the above person is qualified and deserving to receive the **"Ham of the Year"** award because of the following reasons:

Signed _____

Call _____

The **"Ham of the Year"** ballot is very important as it helps the board of directors make the selection. This is not a popularity contest, but input is necessary from the membership.

GENERAL CLASS



TONY/KA9NYO



DON/KA9ODX



DAVID/KA9NYJ



BERT/KA9NYL



DUANE/KA9MOR



GLORIA/KA9NYP



BILL/KA9MOQ



DAVID/KA9NYN



MARVIN/N9BXQ



KAY/KA9OIJ

Potpourri

Our friend Dean/WD9FLO, had his Azden "lifted" from his car during September. He was trying to get rid of it but not quite in this way. The thief didn't take the power cord which will make it rather difficult to use. Sorry to learn about the loss Dean.

A lot of hams from this area went to Grays Lake -Expo '82 last month. Yours truly was one of four that attended including Bob/N9AXD, Floyd/K9CUQ, and Larry/K9LUX. We each spent a few bucks but we were not among the big spenders. I don't believe there were as many dealers there this year as last. Never the less it was fun looking at stuff that most of us would call junk while others ran across something they needed or could put to good use.

Most of us will agree with the comments made by Sheri/WB9SFT, last month concerning the use of the repeater. One of my pet peaves has been the quick way hams key their mike without waiting two or three seconds. It would be a good thing if we all tried harder to set a good example for others, especially new comers to ham radio.

Did the election results suit everyone? Perhaps

not, however it's hard to avoid disappointments. The majority rules and those voted in office will try their best to satisfy. So let us wait and see what happens.

Many nice things happen on ham radio. Recently on 14mhz, Gertrude/KB9PC, heard an OE talking and, from the way he talked, she knew that he was Austrian. She tried to get a better copy on him but was not successful until he said his call OE/VK and said he was visiting a friend in australia. Dick/N9UN, happened to be on frequency. He mentioned that Gertrude had a birthday and they sang *HAPPY BIRTHDAY* to her in German. I didn't know it was legal to sing over the air!

Larry/K9LUX, is a guy who is always thinking up ways to get his name before the public. This time he really started something. Most of his friends in the area probably know it by know but his XYL expects to present him with a little "harmonic" about April 1st. Some might say that Larry was a bit slow getting down to business. Never-the-less, it's a great business and I am sure he would say *RODGER* to that. Congratulations on the coming event Larry and we hope it's twins!

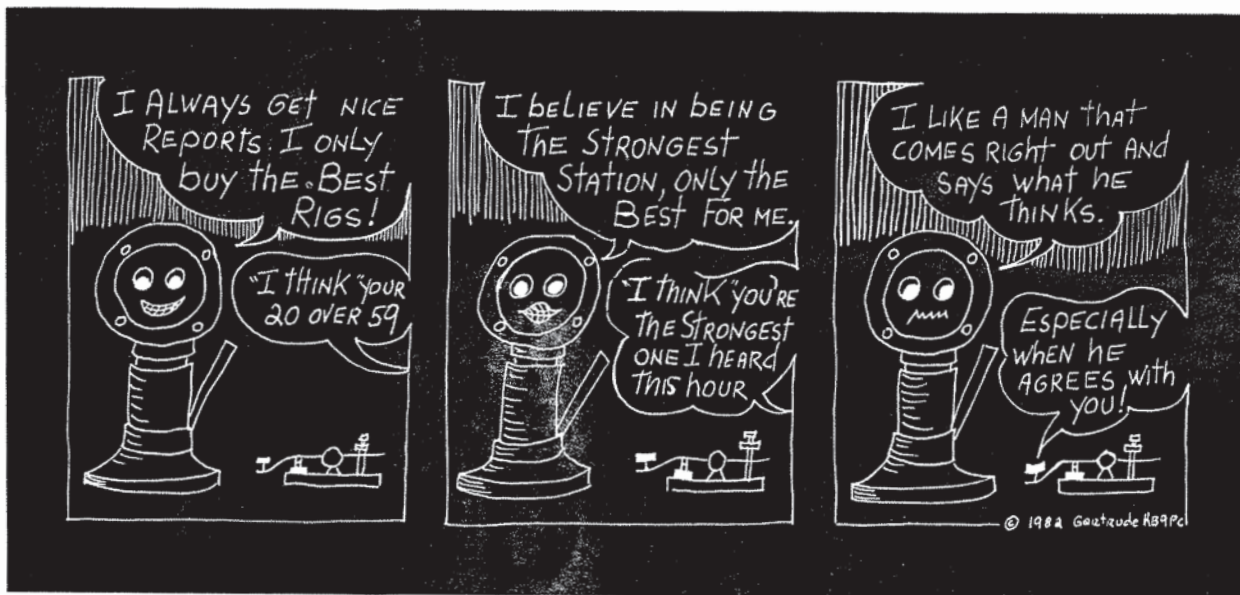

Ham Mart

FOR SALE

FOR SALE

Allied Receiver - Model A-2516 and Speaker.

Heath DX40 Transmitter.

Heath VFL VFO and Power Supply.

Johnson TR Switch.

Archer SWR Bridge.

All in working order and all have manuals. Only sold
as a package — \$100.

Duane Hyland, WB9LEF — 398-7597

**ROCKFORD AMATEUR RADIO ASSOCIATION
P.O. BOX 1744 ROCKFORD, ILLINOIS 61110**

ADDRESS CORRECTION REQUESTED

BULK RATE
U. S. POSTAGE

PAID

ROCKFORD, IL
Permit No. 230

NETS:

28.7 Mhz. Monday 9:00 p.m.

50.4 Mhz. Nightly 9:00 p.m.

146.01/.61 Mhz. Monday 8:00 p.m.

**BLACK HAWK VALLEY
TEN TEN INTERNATIONAL**

28.925 Mhz. Wednesday 9:00 p.m.

21.130 Mhz. Thursday 9:00 p.m.